

Pos.	Menge	Beschreibung	Material	S-Nr.	Art.-Nr.	CAD-Nr.
1	2	Halterplatte PS452	EN AC-46000	PS452	(021402)	4908 A
2	1	Halterprofil PS402 L=38mm	EN AW-6060 T6	PS402	(008673)	10087
3	4	Blechschaube ISO 14585 Tx - ø4.2 x 25	A2-70	-	020314	-
4	2	Nutenstein M8x18mm	A2-70	-	020406	4913
5	2	Unterlagscheibe DIN 433 - 8.4- A2	A2	-	002550	-
6	2	6kt-Mutter ISO 4034 - M8	A2-70	-	005108	-

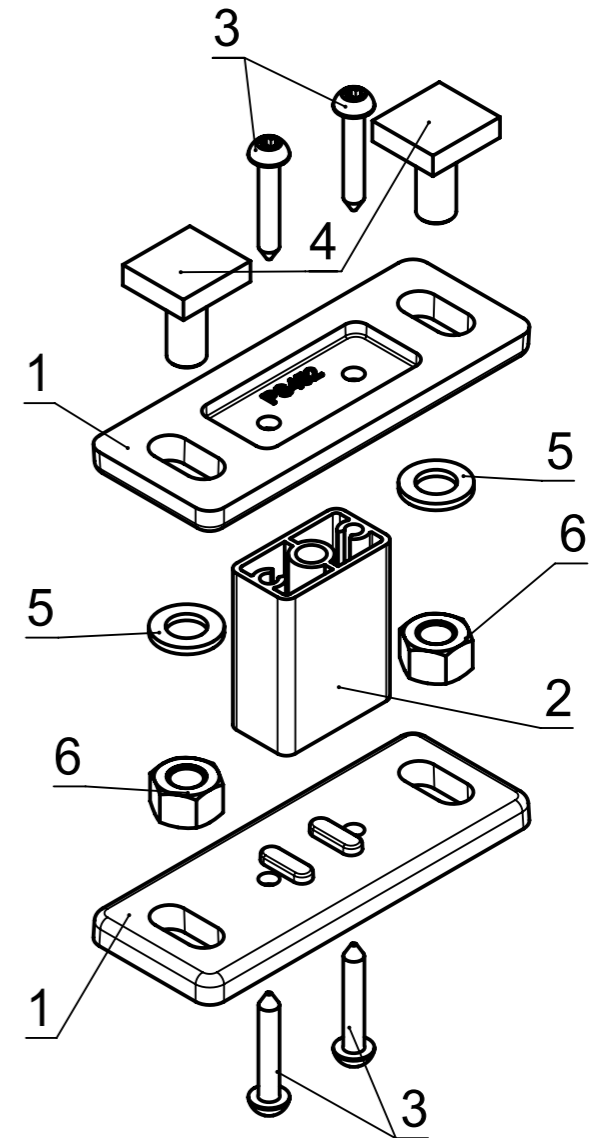

Gewicht: 168.06g
 für Extrusionsprofile g/m

Gezeichnet: ISB	08.05.2003	Stobag-Nr.: PS681/1	Projekt-Nr.: -	Seite 12	Seiten 22	Format A3	Massstab 1:1
Ersetzt:		Stobag Artikel-Nr./Beschreibung		Material: -			
Ersetzt durch: -	-	(071509)		AA-Nr.:			
STOBAG			Befestigungshalter PS681/1	CAD-Nr. Rev.			
Schweizer Qualität - Swiss quality			Fixing bracket PS681/1	10094-12			
			PS6000				