

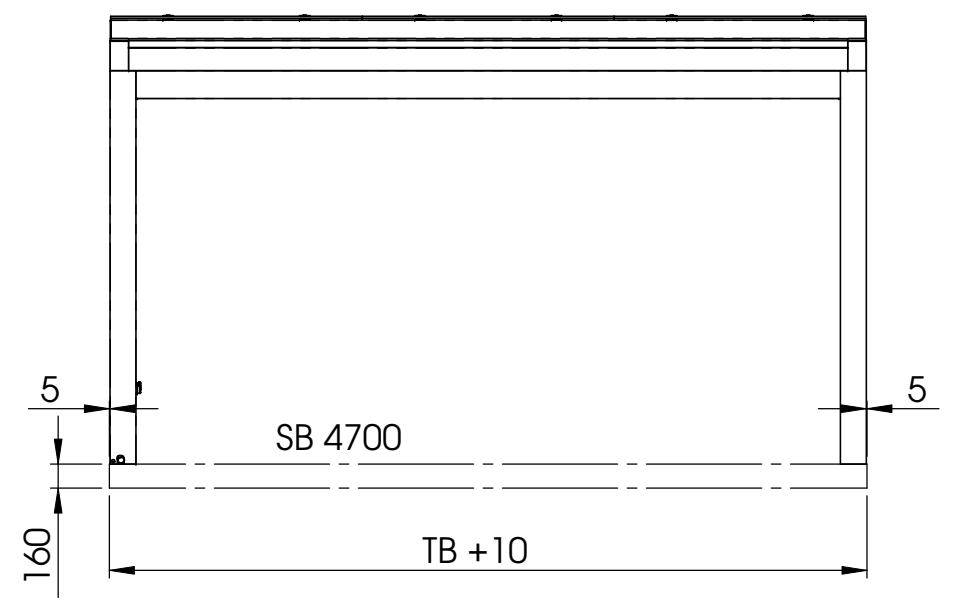

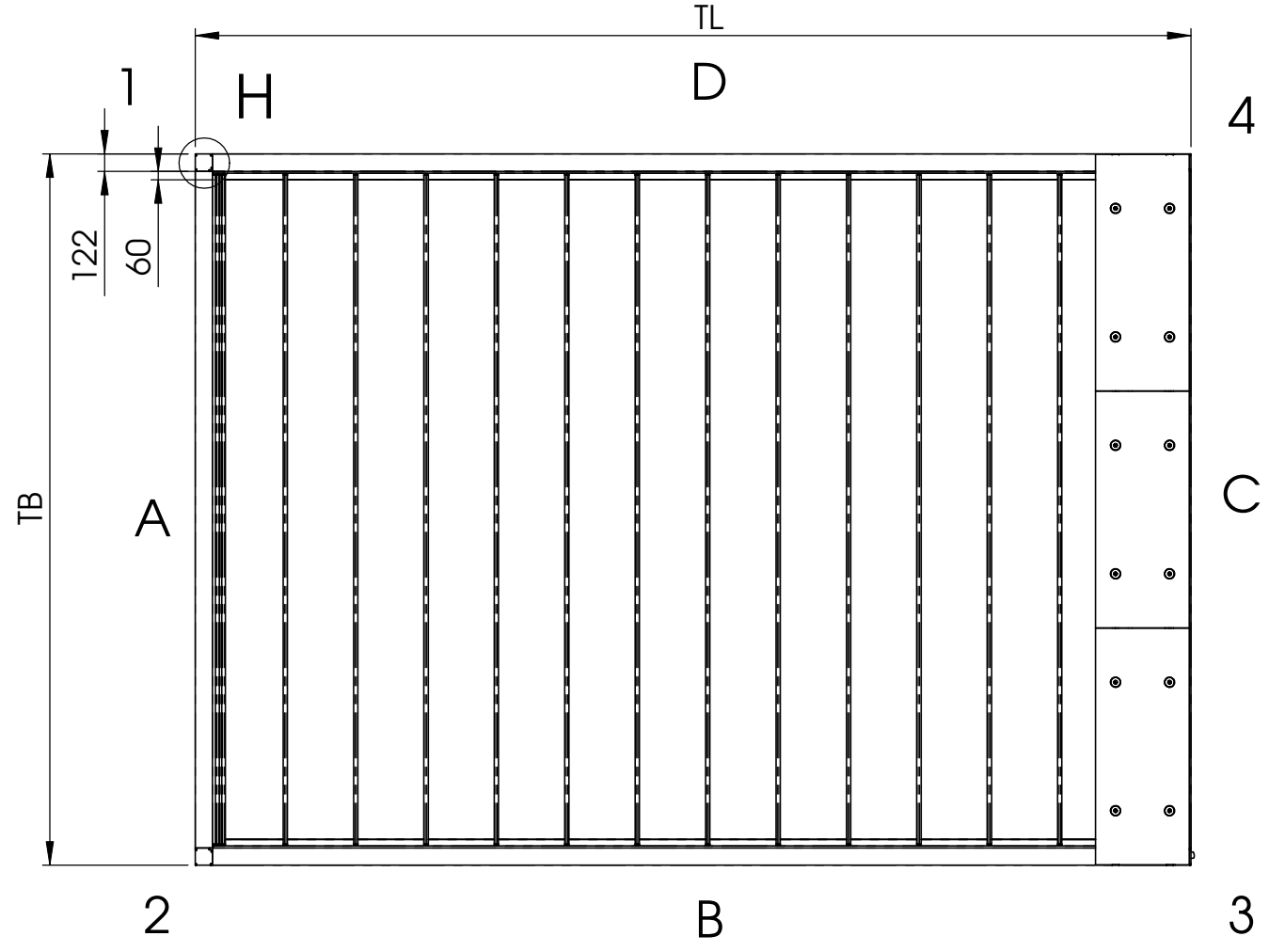

Dieses Dokument ist unser geistiges Eigentum. Es darf ohne unsere ausdrückliche Genehmigung weder kopiert, vervielfältigt oder
 verwendet, noch an Dritte weitergegeben werden. Zuwiderhandlung ist strafbar und wird strafrechtlich verfolgt.
 We reserve all rights in this document and the information contained therein.
 Reproduction, use or disclosure to third parties without express authority is strictly forbidden.
 © 2012 Stobag, CH-5630 Muri, Switzerland

Alle Masse in Millimeter

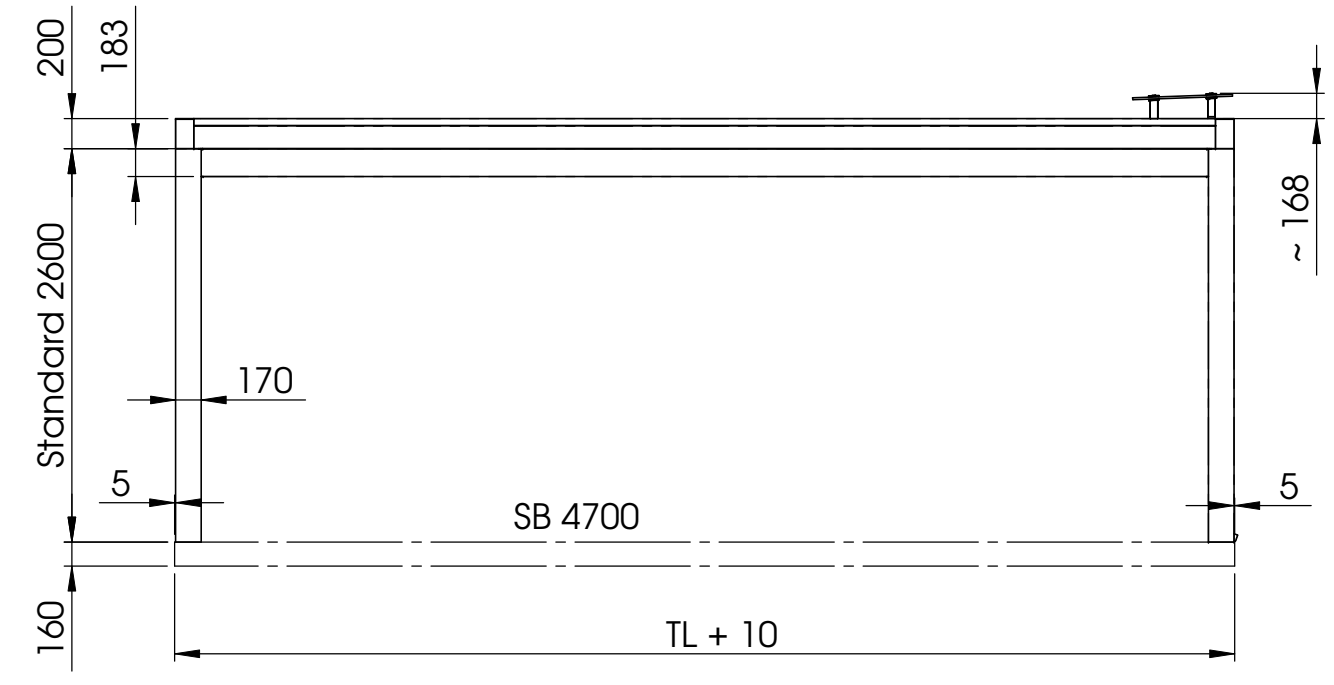
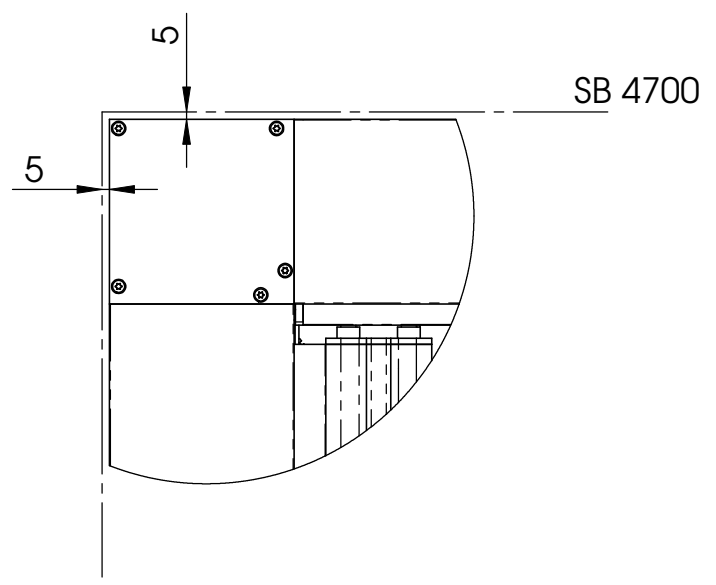

DETAIL H
MAßSTAB 1 : 5



Gezeichnet: 12.12.2012 / Rze	Status: freigegeben	Oberfl:	Gewicht: 759765.05g für Profile g/m			
Geprüft : 12.12.2012 / Rha	Status Datum: 12.12.2013	Status Name: Rha	Material: -			
Ersetzt:	Produkt-Familie:	Seite	Seiten	Format	Massstab	
Ersetzt durch:	Art.-Nr:	4	4	A3	1:50	
 Premium Swiss Quality 		Projekt:		Rev.		
		Stobag-Nr. TP 7000/ TP 400 Melano		 12788-4		